

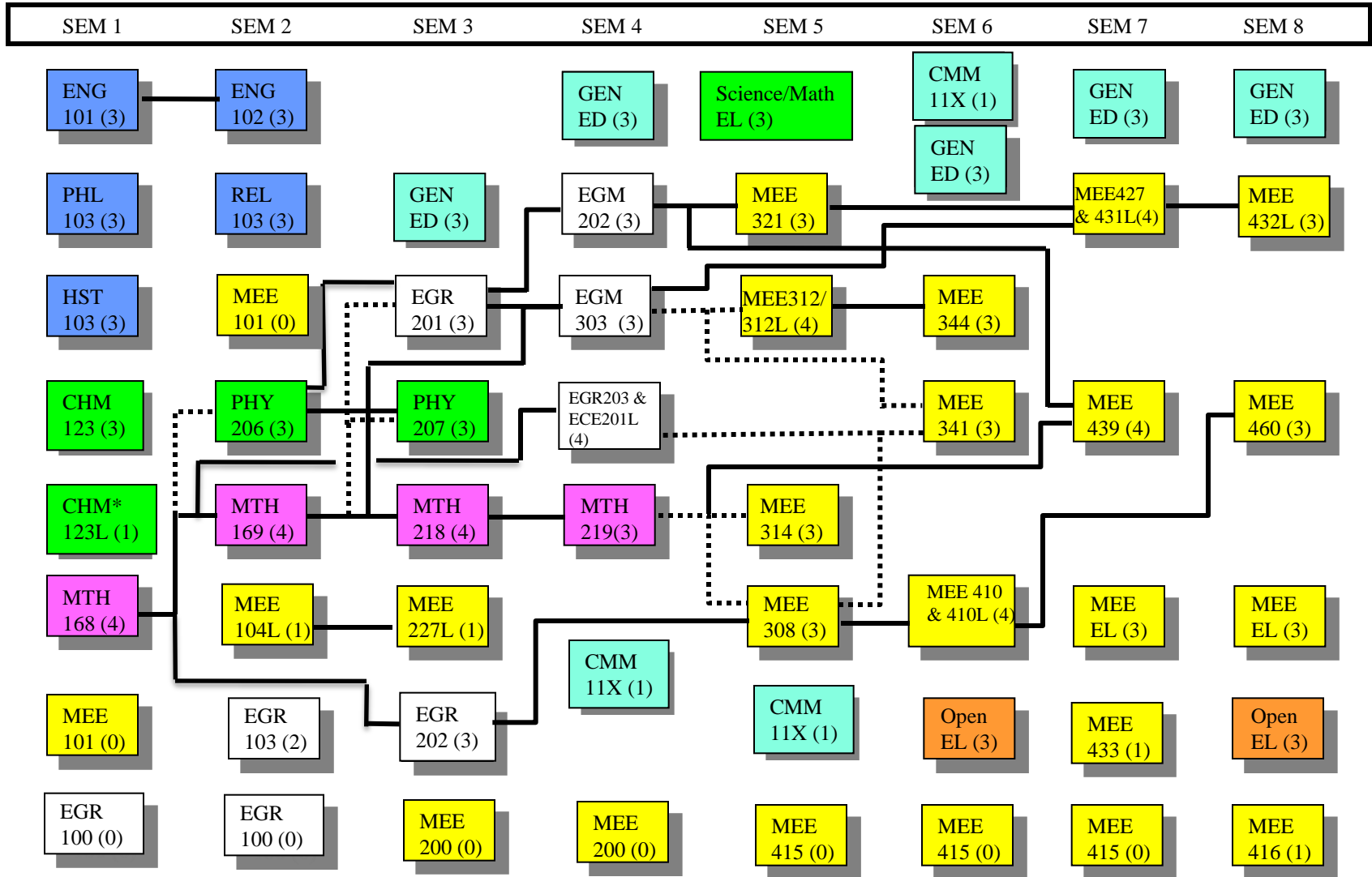







BACHELOR OF MECHANICAL ENGINEERING 2011



	Humanities base		Science		MEE course		Corequisite	* PHY210L can be taken instead. If so, switch PHY206 and CHM123.
	General education elective (5 areas, 3 in cluster) and CMM 110, CMM 111 or 112 and CMM113		Math		Open elective		Prerequisite (left to right)	