

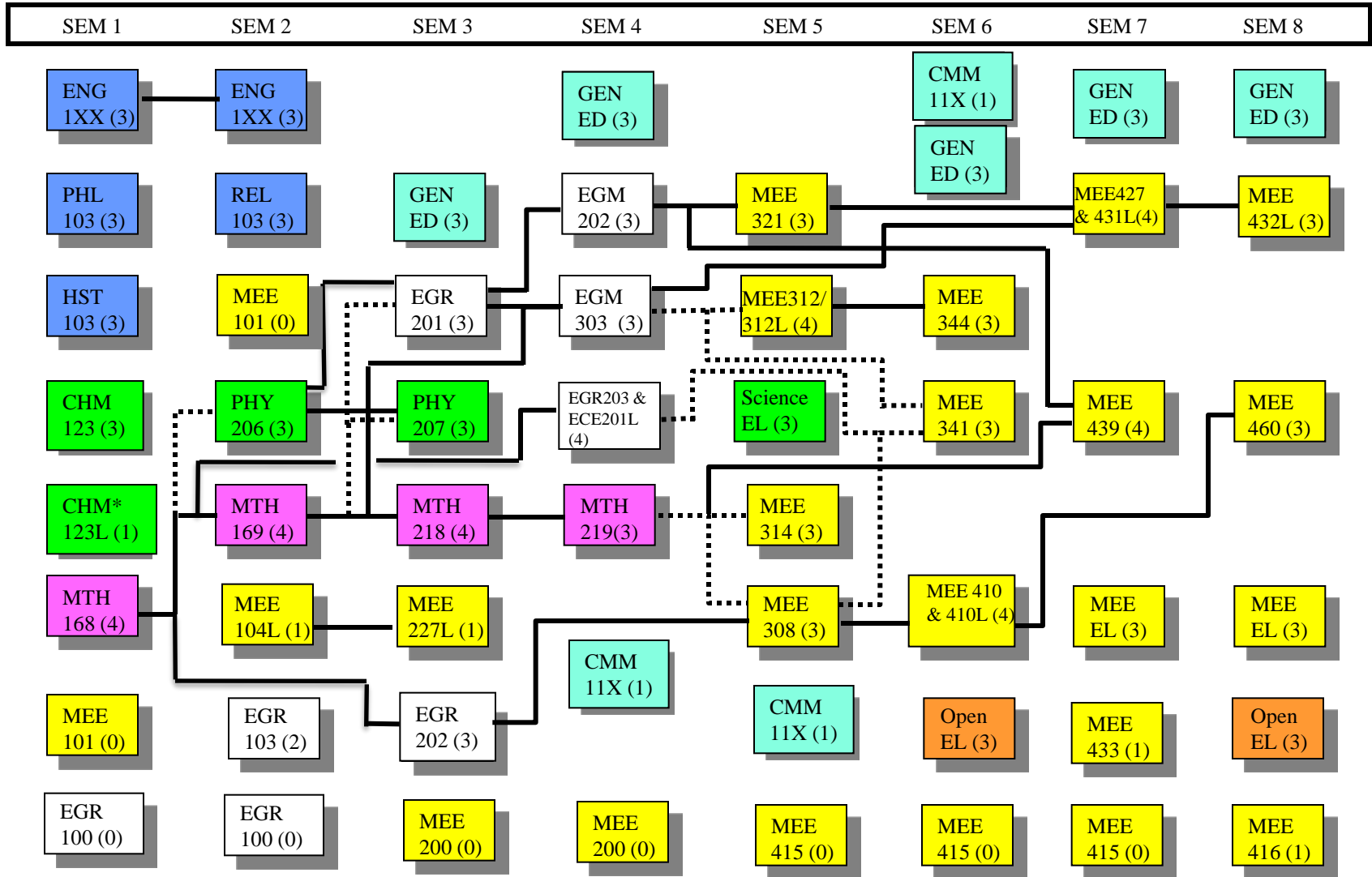







BACHELOR OF MECHANICAL ENGINEERING 2010



 Humanities base	 Science	 MEE course	 Corequisite	* PHY210L can be taken instead. If so, switch PHY206 and CHM123.
 General education elective (5 areas, 3 in cluster)	 Math	 Open elective	 Prerequisite (left to right)	