

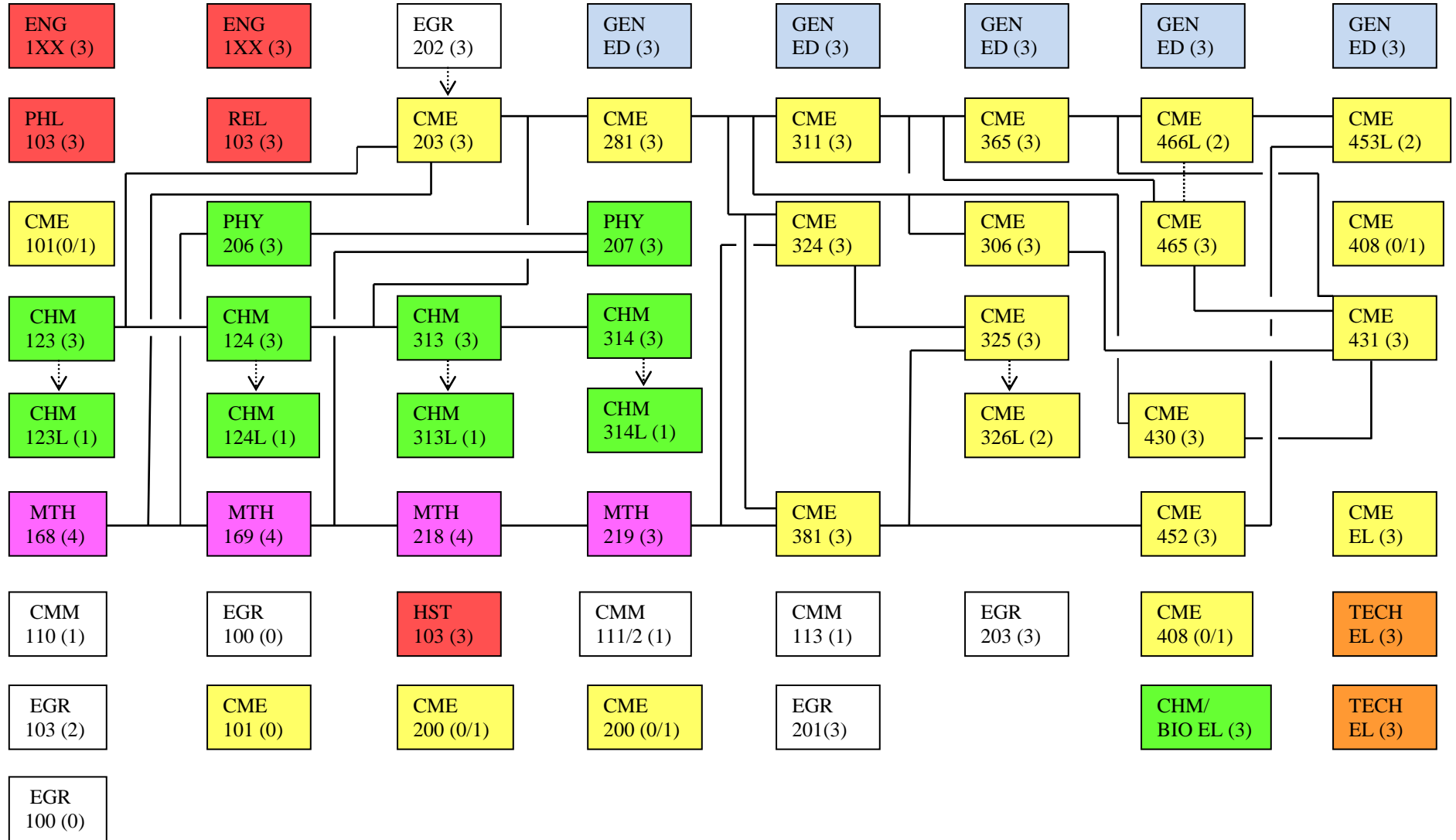





Bachelor of Chemical Engineering 2011

1 st Sem 17/18 Cr.	2 nd Sem 17 Cr.	3 rd Sem 17 Cr.	4 th Sem 17 Cr.	5 th Sem 16 Cr.	6 th Sem 17 Cr.	7 th Sem 17/18 Cr.	8 th Sem 17/18 Cr.
----------------------------------	-------------------------------	-------------------------------	-------------------------------	-------------------------------	-------------------------------	----------------------------------	----------------------------------



	Humanities Base		General Education Electives (5 courses: Three in different domains may be used for cluster. One must be an ethics course.)		CME Course		Technical Elective (list of approved electives in CME Office) Co-Requisite
	General Science				Math			_____ Prerequisites