

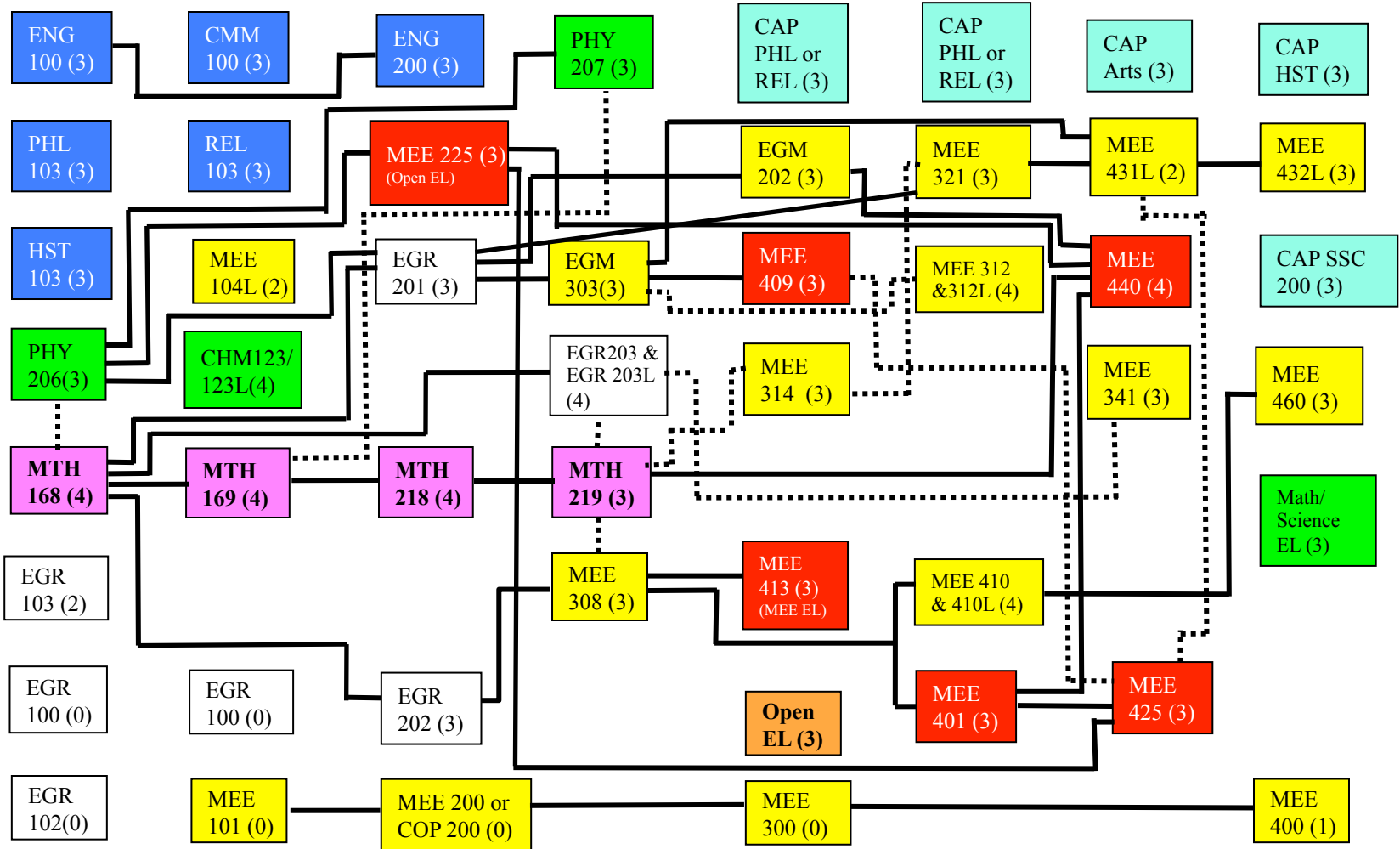









BACHELOR OF MECHANICAL ENGINEERING – Aerospace Concentration 2016

SEM 1 18CR SEM 2 16CR SEM 3 16CR SEM 4 16CR SEM 5 18CR SEM 6 17CR SEM 7 15CR SEM 8 16CR



	CAP Base		Science		MEE course		Corequisite	* PHY210L can be taken instead. If so, switch PHY206 and CHM123.
	Aerospace		Math		Open elective		Prerequisite	
	Common Academic Program (CAP)		Integrated Engineering Core					