

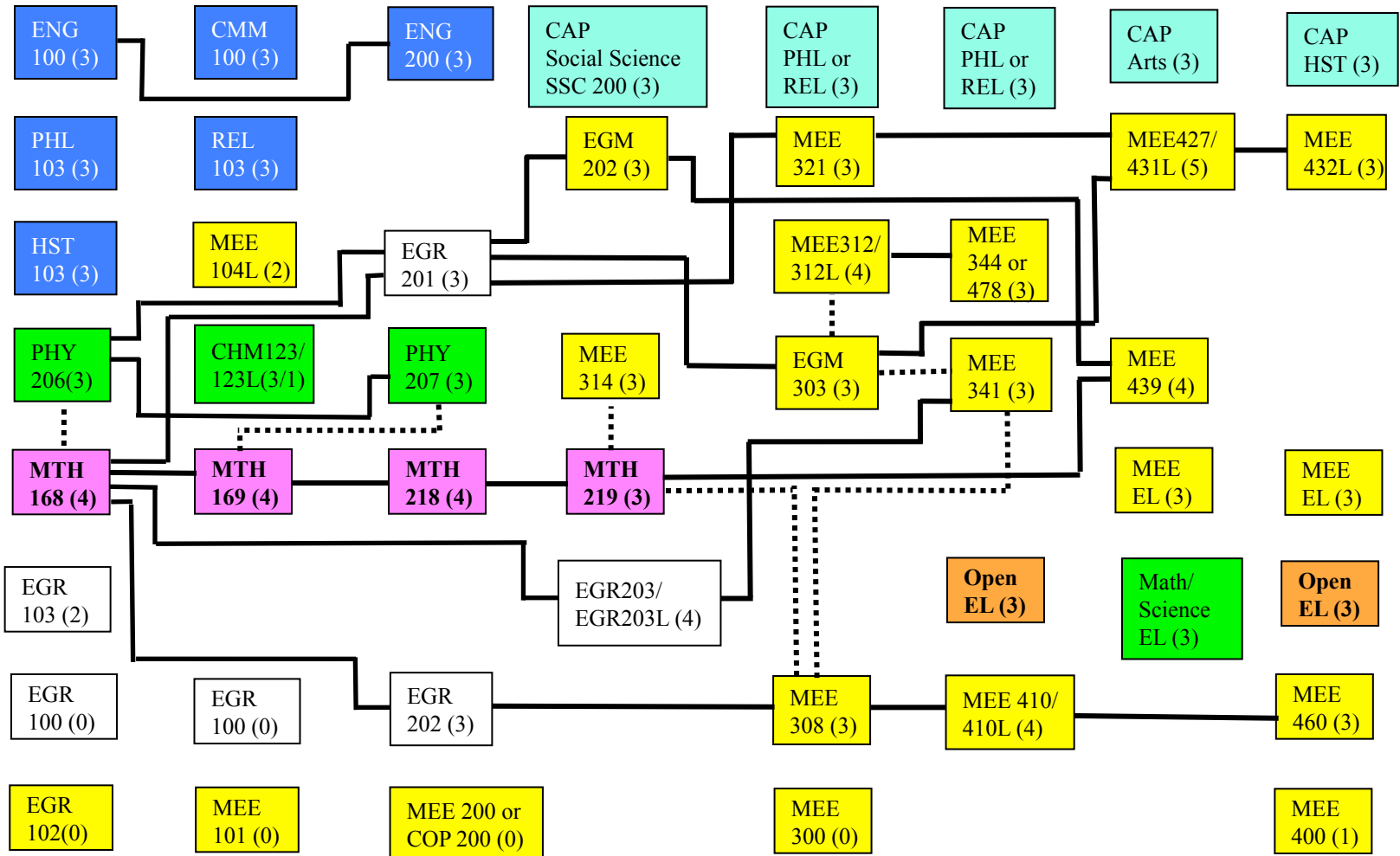









# BACHELOR OF MECHANICAL ENGINEERING 2016

**SEM 1 18CR    SEM 2 16CR    SEM 3 16CR    SEM 4 16CR    SEM 5 16CR    SEM 6 16CR    SEM 7 18CR    SEM 8 16CR**



 CAP Base	 Science	 MEE course	 Corequisite	* PHY210L can be taken instead. If so, switch PHY206 and CHM123.
 Common Academic Program (CAP)	 Math	 Open elective	 Prerequisite	
	 Integrated Engineering Core			