

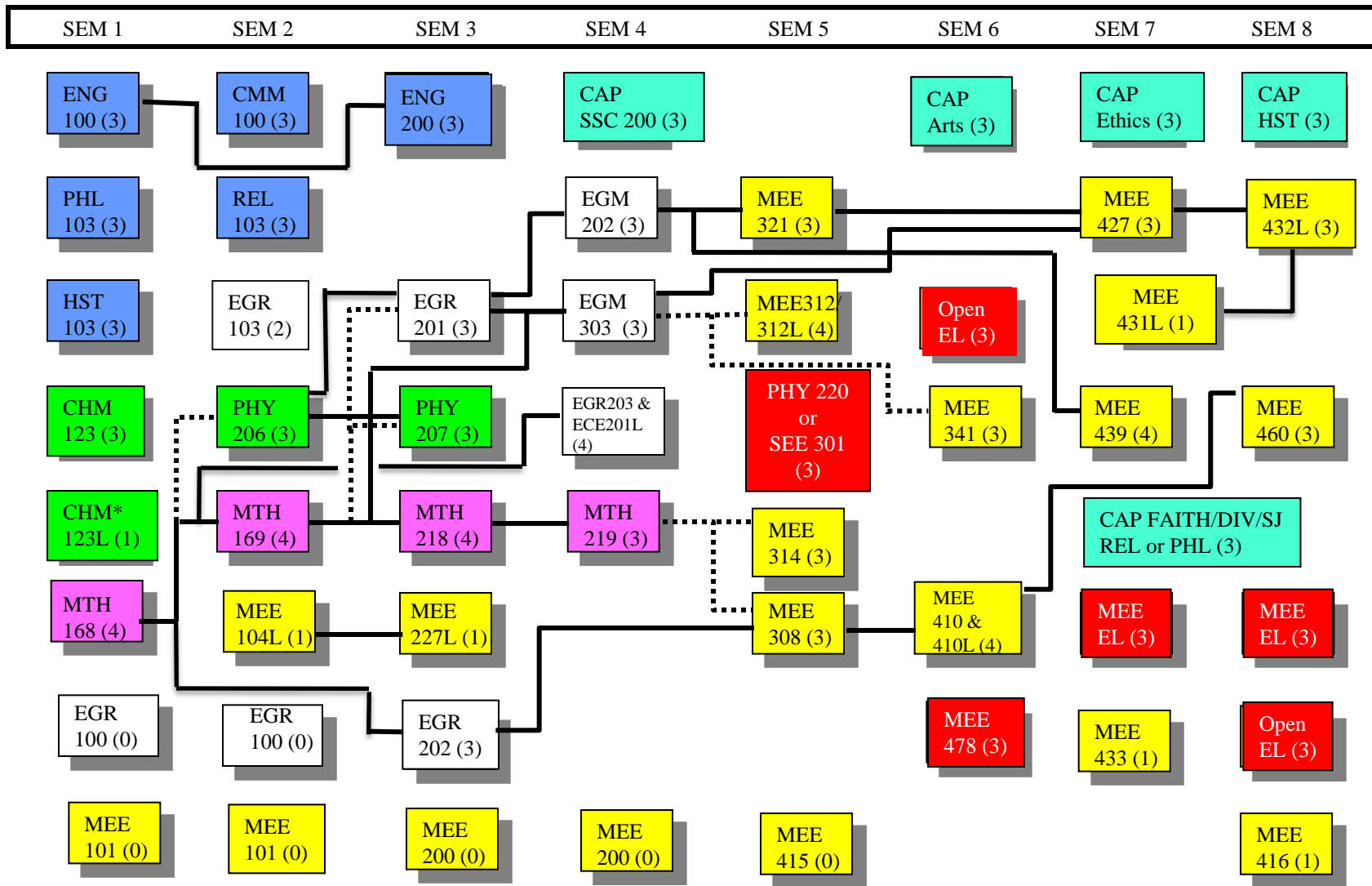







BACHELOR OF MECHANICAL ENGINEERING (ENERGY SYSTEMS CONCENTRATION) 2013



	Humanities base		Science		MEE course		Corequisite	* PHY210L can be taken instead. If so, switch PHY206 and CHM123.
	Math		Open elective		Prerequisite (left to right)			
	Common Academic Program (CAP)							